

Tilt Beam Sensor



辉格科技
Vigor Technology

Tilt Beam Sensor

Features

- Based on patented high performance SST300 inclinometer
- High resolution, accuracy & stability
- Customized measurement range
- High safety remote transmission and easy to set-up networks
- U- Shaped openings in both ending, easy to connect more sensors
- IP67 protection
- Alloyed & anodized aluminum housing



Application

- Buildings and structures adjacent to deep excavation and continuous wall
- Buildings and structures impacted by tunneling and mining
- Subgrade treating, grouting & supporting structure.
- Oil tank
- Retaining wall
- Subside and collapse

Description

Based on patented SST300 inclinometer, Vigor developed tilt beam sensor for civil engineering industry, by combined various accessories and options, achieve mostly facilitates field applications.

The beam housing SST300 is used to measure rotated angel of two fixed points. Install sensor into hard beam (standard length is 1m, others are optional), fix sensor in monitored structure, by rotated angel can conversion out displacement data of beam length. Many sensors can be integrated to set up a PLC/DAQ system, so end user can remotely monitor horizontal & vertical gesture of the application, such as dam, tunnel and excavation wall. Please refer to picture 1.



Picture 1 Level bending diagram

Generally, we install the tilt beam sensor with expansion bolt, screw by grout, or epoxy anchor, refer to picture 2.

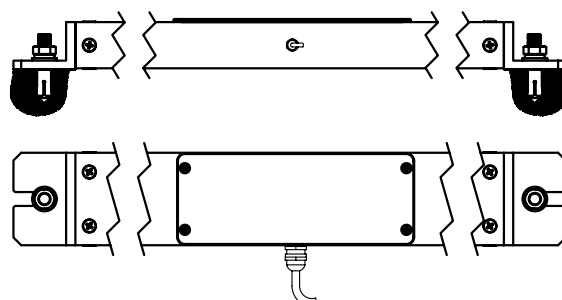

Picture 2 Installation

Performances

Table 1 Specifications

Measurement range		±5°	±10°	±15°
Combined absolute accuracy ^① (@25 °C)		±0.01°(0.17mm/m)	±0.015°(0.26mm/m)	±0.02°(0.35mm/m)
Subroutine parameter	Absolute linearity (LSF)	±0.06%FS	±0.03%FS	±0.03%FS
	Cross-axis sensitivity ^②	±0.1%FS		
	Offset ^③	±0.005°(0.1mm/m)		
	Repeatability	±0.0025°(0.05mm/m)		
Hysteresis		±0.0025°(0.05mm/m)		
Input axis misalignment ^④		±4.0°	±3.0°	±2.5°
Sensitivity temp. drift coefficient		≤100ppm/ °C		
Offset temperature drift coefficient		≤0.003° (0.06mm/m)/ °C		
Offset turn on repeatability ^⑤		±0.008°(0.15mm/m)		
Resolution		0.0025°(0.05mm/m)		
Long-term stability @ 1year ^⑥		≤0.02°(0.4mm/m)		
Measurement axes		1 axes		
Temperature sensor		Range : -50~125°C , Accuracy:±1°C		
Output		RS232(standard) , Optional 5 types, please refer to accessories table3.1		
RS232 data format		115200 baud, 8 data bits, 1 start bit, 1 stop bit, none parity,ASCII		
Cold start warming time		60s		
Response time ^⑦		0.3s @t ₉₀		
Refresh rate(digital output)		5Hz (Standard), optional 10Hz, 20Hz		
Response frequency ^⑧		3Hz @-3dB		
Power supply		9 ~ 36VDC		
Power consumption		Average working current≤50mA; average power≤1.5W (25□&24VDC)		
Operation temperature range		-40 ~ 85°C		
Storage temperature range		-60~100°C		
EMC		According to EN 61000		
Insulation resistance		100MΩ		
MTBF		≥25000 hours		
Shock survival		100g@11ms, three-axis, half sine		
Anti-vibration		8grms, 20 ~ 2000Hz		
Protection		IP67		
Connector		Metal pigtails		
cable		7-wire shielded cable with tensile reinforcement, heavy duty up to 30Kg		
Weight		1.3Kg(with connector and cable,1M length of housing)		

Remark:

- ① Combined absolute accuracy means the compositive value of sensor' s absolute linearity, repeatability, hysteresis, offset and cross-axis sensitivity error. (in room temperature condition) as
$$\Delta = \pm \sqrt{\text{absolute linearity} + \text{repeatability} + \text{hysteresis} + \text{offset} + \text{cross-axis sensitivity}^2}$$
- ② The cross-axis sensitivity error means the angle that the tilt sensor may be banked to the normal tilt direction of sensor. The cross-axis sensitivity (±0.1%FS) shows how much perpendicular acceleration or inclination is coupled to the inclinometer output signal. For example, for the single-axis inclinometer with range ±30° (assuming the X-axis as measured tilt direction), when there is a 10° tilt angle perpendicular to the X-axis direction(the actual measuring angle is no change, example as +8.505°), the output signal will generate additional error for this 10° tilt angle, this error is called as cross-axis sensitivity error. SST300's cross-axis sensitivity is 0.1%FS, the extra error is 0.1%×30° =0.03° (max) , then real output angle should be +(8.505° ±0.03°). In SST300 series, this error has been combined into the absolute accuracy
- ③ Offset means that when no angle input (such as the inclinometer is placed on an absolute level platform), output of sensor is not equal to zero , the actual output value is zero offset value.
- ④ Input axis misalignment means during the installation, the allowable installation angle deviation between actual tilt direction and sensor' s nature measurement direction. In general, when installed,SST300 sensor is required that the measured tilt direction keep parallel or coincident with sensor designated edge, this parameter can be allowed a certain deviation when sensor is installed and does not affect the measurement accuracy.
- ⑤ Offset turn on repeatability means the repeatability of the sensor in repeated by supply power on-off-on many times.
- ⑥ Long-term stability means the deviation between the statistics of the maximum and the minimum output value after a year of continuous power supply when the sensor is at 20°C .
- ⑦ The response time refers to the angle sensor in a step change (such as the angle changes from -10 ° to +10 ° within 5ms), the time required that output of the sensor achieved to the standard value of 90%. The index is different from the sensor set-up time
- ⑧ Response frequency is for the limitation of the dynamic measurement range, when the dynamic measurement exceeds 3 Hz, because of centripetal force, the output occupied additional random error, this error is difficult to define.

Dimensions (mm)

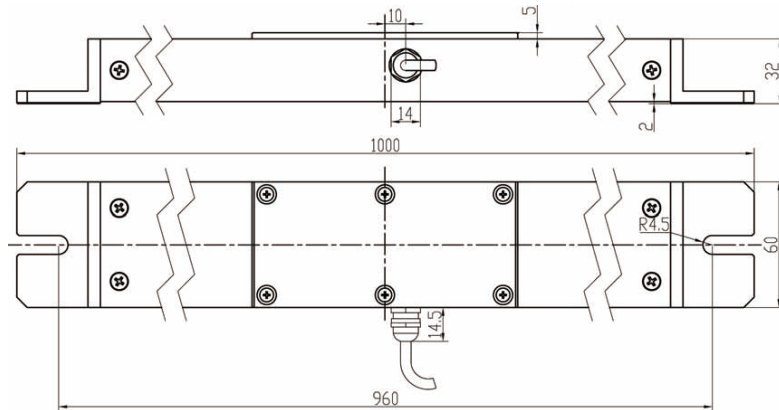

Wiring

Table 2 Output wiring

Cable wire color	Output						
	4~20mA	-5~+5VDC	RS232	RS485	CAN	TCP/IP	Wi-Fi
Red	Power+	Power+	Power+	Power+	Power+	Power+	Power+
Black	Power-	Power-	Power-	Power-	Power-	Power-	Power-
Green	Signal GND	Signal GND	Signal GND	Signal GND	NC	Shield GND	NC
Yellow	Iout	Vout	NC	NC	NC	E-RXD+	NC
White	NC	NC	NC	NC	NC	E-RXD-	NC
Blue	NC	NC	TXD	RS485-A	CAN-H	E-TXD+	NC
Brown	NC	NC	RXD	RS485-B	CAN-L	E-TXD-	NC

Ordering

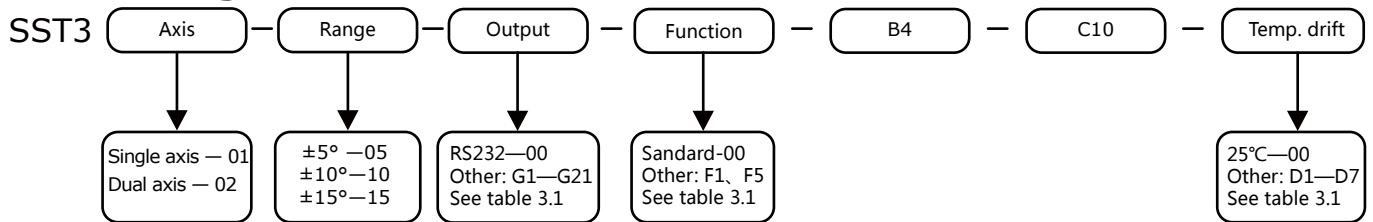







For example: if order a tilt beam sensor, with range $\pm 5^\circ$, room temperature accuracy $\pm 0.01^\circ$, $-20\sim 60^\circ\text{C}$ accuracy ± 0.02 , Wi-Fi wireless transmission, 2 meters cable, GPS function, the model should be chosen as: SST301-05-G12-F1-B4-C10-D3.

Other options (see table 3.2):

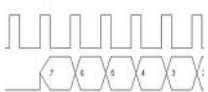
Complementary power combined with solar and wind energy— order number SST003-09-03.



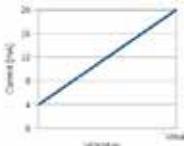
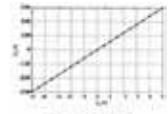

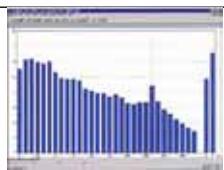
iAngle+ PC application software— order number SST003-04-10-02.

Table 3.1 Accessories

Item	Order Code	Name	Function
Output interface	G1	 RS485 output	RS-485 transceiver isolated, compatible with half-duplex or full-duplex communication $\pm 15\text{kV}$ ESD protection for RS-485 physic pin Compatible with ANSI/TIA/EIA-485-A-98 and ISO8482:1987(E) According to UL1577---2500V rms for 1min Transmission rate up to 500 kbps, support 256pcs node max High common mode transient suppression ability $>25\text{kV/us}$ Support ModBus-RTU, with HEX or ASCII communication
	G3	 CAN output	According to ISO/DIS 11898, twisted-pair output Support CAN2.0A, CAN2.0B protocol Built-in high speed photoelectric isolation Support 15 types baud rate (5-1000Kbps) Transmission distance is 10km max
	G9	 TCP/IP interface	10/100M, self-adaption Ethernet interface Support AUTO MDI/MDIX, can use cross-ruling or parallel cable Support DNS, satisfy the communication needs by domain name Support single or multiple PC communication in UDP mode Baud rate is 300bps~230.4kbps, adjustable Operating mode: TCP Server, TCP Client, UDP, Real COM driver, etc. Disconnect automatically after detach GSM
	G12	 WiFi interface	WLAN standard: IEEE 802.11b/g, compatible to Wi-Fi, 2.4G ISM Output power: 15dBm +/-1.5dBm typical Wireless transmission rate: 802.11b: 1, 2, 5.5, 11Mbps 802.11g: 6, 9, 12, 18, 24, 36, 48, 54Mbps Wireless net work set up: support AP and Ad-Hoc Encryption: support WEP40 and WEP104 (64/128 bit) Setting time: less than 3~6s (depend on encrypt method)
	G19	 4~20mA output	Output current and Angle data in proportion precisely Linearity: 0.02%FS max Output impedance 39 Ω , allow load impedance 625 Ω max Overheating and against access protection Built-in to SST300 inclinometer
	G21	 -5~+5VDC output	Output voltage and Angle data in proportion precisely Linearity : 0.02%FS max Output impedance 100 Ω , output current $\pm 10\text{mA}$ max Short circuit and transient voltage protection Built-in to SST300 inclinometer
Functional module	F1	 GPS module	Positioning accuracy 2.5m CEP; 2.0m @ SBAS Local gravity acceleration automatic correction Time pulse accuracy: 30ns RMS Original data refresh rate: 4Hz Speed accuracy: 0.1m/s Receiver type: GPS L1 band, C/A code; GALILEO Open Service GLONASS FDMA SBAS: WAAS, EGNOS, MSAS Higher positioning accuracy GPS available
	F5	 Vibration module	Three-axis vibration detection, frequency response $\leq 5\text{ kHz}$ Range: 0 g~ $\pm 1\text{ g}$ / $\pm 5\text{ g}$ / $\pm 10\text{ g}$ / $\pm 20\text{ g}$, adjustable Sampling time(real-time): 20.48 kSPS Filter programmable, 11pcs set points FFT, 512-point, real valued, all three-axis (x, y, z) Three windows: Rectangle, Hanning, Flat tope, adjustable FFT average value programmable, 255 max Storage: 14 FFT records on all three-axis (x, y, z) Alarm programmable, 6pcs spectrum

Temperature drift	D1	Temperature drift	Temp. compensation range 0~60°C , temp. drift accuracy $\pm 0.01^\circ @ \leq \pm 30^\circ$
	D3	Temperature drift	Temp. compensation range -20~60°C ,temp. drift accuracy $\pm 0.02^\circ @ \leq \pm 30^\circ$
	D5	Temperature drift	Temp. compensation range -30~6 °C , temp. drift accuracy $\pm 0.03^\circ @ \leq \pm 30^\circ$
	D7	Temperature drift	Temp. compensation range -40~65 °C , temp. drift accuracy $\pm 0.05^\circ @ \leq \pm 30^\circ$

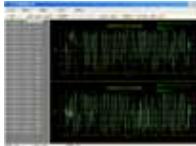
Table 3.2 Option

Item	P/N	Name	Function
Display	SST003-04-01	 Single LED Instrument	Suitable for connecting with single-axis inclinometer Support RS485, RS232 serial output interface, MODBUS RTU protocol Password of Parameter setting locked and stored permanently when interrupt, restore factory setting function 0.2% accuracy Double LED display, and with bar display (0~100%) AC input 100-240V(50-60Hz) Output 20-29VDC can directly supply to inclinometer More information please refer to <SST003-04-01 datasheet>
	SST003-04-02	 Dual LED Instrument	Suitable for connecting with dual-axe, or two pieces single-axe inclinometer. Support RS485, RS232 serial output interface, MODBUS RTU protocol Password of Parameter setting locked and stored permanently when interrupt, restore factory setting function Mathematical functions including plus (minus), multiply and divide. 0.2% accuracy Double LED display, and with bar display (0 ~ 100%) Input 100-240VAC (50-60Hz) Output 20-29VDC, can directly supply to inclinometer More information please refer to <SST003-04-02 datasheet>
	SST003-04-09	 PC application software	Setting: Serial interface communication settings, data save settings, data display settings, charts display settings, alarm settings Command: Zeros, filter factor, refresh rate, local gravity acceleration value, ID address, output method Tooling: Zero calibration, sensor software upgrades, data playback mode, real-time display mode, cursor display mode, sensor data Viewgraph: Status bar, tool bars, data area and chart area Operation: Windows XP, Windows 7 More information please refer to < SST003-04-09 datasheet>
	SST003-04-10-01	iAngle PC application software	Suitable for iPhone series products Communication distance $\geq 200m$ Tilt data inspect & settings: Zero, range, sampling rate, filter coefficient, etc Functions: alarm, graph, compass chart, bubble chart Sampling rate: 20time/sec
	SST003-04-10-02	iAngle ⁺ PC application software	Suitable for iPad series products Communication distance $\geq 200m$ Sapling rate: 20 times/s Tilt data inspect & settings: Zero, range, sampling rate, filter coefficient, etc Functions: alarm, graph, compass chart, bubble chart
	Power	SST003-09-03	 Complementary power
Test report	SST003-11-01	Test report for cross-axis error	Accuracy test report under banking tilt, average 11 points of full range
	SST003-11-02	Test report for absolute linearity	Average 21 points of full range
	SST003-11-08	MTBF analysis report	MTBF statistical analysis report
	SST003-11-09	FMEA analysis report	FMEA analysis report
	SST003-11-10	Test report for life simulation	Test report for zero position and full range under 7 days continuously power on.
	SST003-11-12	Test report by China National organization	Average 5 points of full range by Shanghai Institute of Measurement and Testing Technology(www.simt.com.cn)
	SST003-11-13	Test report for salt spray	According to MIL standard (MIL-810F- 509.4)

Appendix: Angle conversion table

	degrees	arc minutes	arc seconds	μ radians	mm/meter	inches/ft
1 degree=	1	60	3600	17453	17.453	0.2094
1 arc minute=	0.01667	1	60	290.9	0.2909	3.49×10^{-3}
1 arc second=	2.78×10^{-4}	0.01667	1	4.848	4.85×10^{-3}	5.82×10^{-5}
1 μ radian=	5.73×10^{-5}	2.44×10^{-3}	0.2063	1	0.001	1.20×10^{-5}
1 mm/meter=	0.0573	3.436	206.3	1000	1	0.0120
1 inch/ft=	4.775	286.5	17189	83333	83.33	1

Shanghai Vigor Technology Development Co., Ltd.

No.289-4, Bisheng Road, Pudong New District Shanghai China 201204

Hotline. +86-400-0505-021

Tel. +86-21-5840-4921

Fax. +86-21-5835-4552

Email: sales@vigordigital.com

Web: www.vigordigital.com